

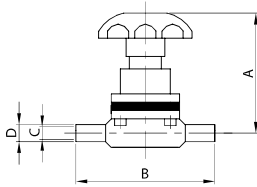

MICROVALVOLA M. EL.
D. MICROVALVE PE.
MINIVANNE MEMBR. EL.
MICROVALVULA M. EL.

S57W



DN	A	B	C	D	gr	
1/4"	6	66,5	67,0	3,9	6,3	190
3/8"	9	66,5	67,0	7,1	9,5	190
1/2"	12	66,5	67,0	9,4	12,7	190

MICROVALVOLA M. E. SM.
D. MICROVALVE E. FR.
MINIVANNE MEMBR. B. FR.
MICROVALVULA M. E. SM.

S57K

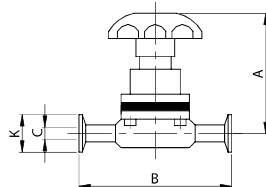

DN	A	B	C	K	gr	
1/2"	12	66,5	67,0	9,4	25,0	200

V. MEMBRANA EL.
DIAPHRAGM V. PE.
V. MEMBRANA BL.
V. MEMBRANA EL.

57W

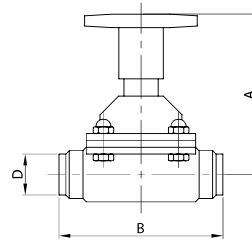

DN	A	B	D	gr	
1/2"	12	78,0	89,0	12,7	840
3/4"	19	79,0	102,0	19,0	1.200
1"	25	92,0	114,0	25,4	1.680
1 1/2"	38	112,0	140,0	38,1	3.140
2"	51	135,0	159,0	50,8	5.040

V. MEMBRANA E. SM.
DIAPHRAGM V. E. FR.
V. MEMBRANA B. FR.
V. MEMBRANA E. SM.

57K

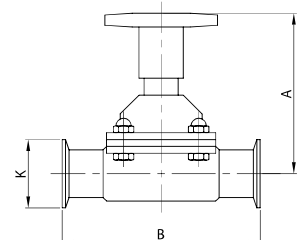

DN	A	B	K	gr	
1/2"	12	78,0	89,0	25,0	840
3/4"	19	79,0	102,0	25,0	1.200
1"	25	92,0	114,0	50,5	1.680
1 1/2"	38	112,0	140,0	50,5	3.140
2"	51	135,0	159,0	64,0	5.040

V. M. PNEUMATICA EL.
PNEUMATIC D. V. PE.
V. M. PNEUMATIQUE BL.
V. M. NEUMÁTICA EL.

58W

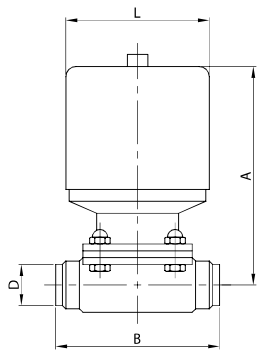

DN	A	B	D	L	gr	
1/2"	12	107,0	89,0	12,7	60,0	1.360
3/4"	19	120,0	102,0	19,0	90,0	2.460
1"	25	124,0	114,0	25,4	90,0	2.780
1 1/2"	38	186,0	140,0	38,1	127,0	6.880
2"	51	200,0	159,0	50,8	127,0	8.160

V. M. PNEUMATICA E. SM.
PNEUMATIC D. V. E. FR.
V. M. PNEUMATIQUE B. FR.
V. M. NEUMÁTICA E. SM.

58K

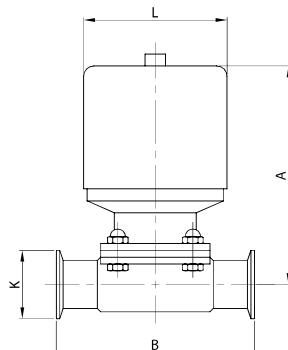

DN	A	B	K	L	gr	
1/2"	12	107,0	89,0	25,0	60,0	1.360
3/4"	19	120,0	102,0	25,0	90,0	2.460
1"	25	124,0	114,0	50,5	90,0	2.780
1 1/2"	38	186,0	140,0	50,5	127,0	6.880
2"	51	200,0	159,0	64,0	127,0	8.160

V. M. UN. CONTROLLO EL.
D. V. CONTROL UNIT PE.
V. M. UN. CONTRÔLE BL.
V. M. UN. CONTROL EL.

60W

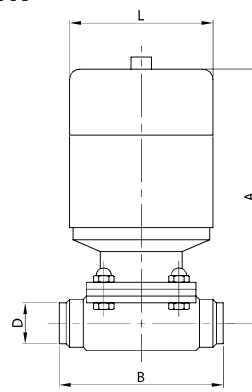

DN	A	B	D	L	gr	
1/2"	12	183,0	89,0	12,7	60,0	1.660
3/4"	19	197,0	102,0	19,0	90,0	3.010
1"	25	201,0	114,0	25,4	90,0	3.330
1 1/2"	38	263,0	140,0	38,1	127,0	7.880
2"	51	277,0	159,0	50,8	127,0	9.160

V. M. UN. CONTROLLO E. SM.
D. V. CONTROL UNIT E. FR.
V. M. UN. CONTRÔLE B. FR.
V. M. UN. CONTROL E. SM.

60K

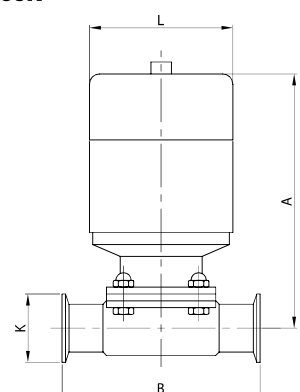

DN	A	B	K	L	gr	
1/2"	12	183,0	89,0	25,0	60,0	1.660
3/4"	19	197,0	102,0	25,0	90,0	3.010
1"	25	201,0	114,0	50,5	90,0	3.330
1 1/2"	38	263,0	140,0	50,5	127,0	7.880
2"	51	277,0	159,0	64,0	127,0	9.160